

1980 – 1988

XI

1980 – 1988

After Sarah and I were married, at last I had peace of mind, a knowledgeable, talented helpmate, and time to get organized and continue my work.

We both had had spiritual experiences: I with the I AM Group with Guy W. Ballard, and his work, Sarah with the teaching of Rev. Marnie Koske, whom she loved dearly. We were both ordained Ministers. I was a Minister of the Universal Church of the Master, and held a Church Charter, though inactive at the time, under their jurisdiction.

Sarah, ordained in Christ's Universal Healing Shrine Churches, had for several years been Pastor of Christ's Holy Presence Church in Florida, and was a member of Sologa Group 49 of Florida. She was an accomplished clear channel, and had done research work over the past ten years with several organizations. She was most interested in the work of George Meek, and his MetaScience Foundation, with whom she had worked over a period of five years, in the early work on "Spiri-Com."

We both felt we should contribute to the work of The Spiritual Hierarchy of this planet, in their endeavor to hold to a minimum the damage being done to Planet Earth by pollution, violence and economic and political problems.

Material was given to us by various authorities and members of the spiritual worlds. Sarah transcribed the tapes; Grace Helen Taylor typed the material; and I organized the material, made the index and put the material together. Larry Blazey, a friend and commercial artist, created the cover design. Julius Egloff (a geology scientist and friend) did a stylized picture for us. This was "Oasis."

In the fall of 1979, we advertised for a semi-retired couple, since we were working long hours, and had not much time to do the chores and the cooking. We ate in

The Story of Eloptic Energy

restaurants most of the time. We hired local people to cut the grass.

One of the psychotronic's group members answered the ad. He was a Board Member and an officer of the U.S. Psychotronic's Association.

I was, at that time, elected Life Member of the U.S.P.A. and "Veteran Director" on the Board.

I thought I could trust this man, since we were associated in the U.S.P.A. What a mistake that was! Thus began the experiences by which I learned about Peter Kelly, and my so-called "friends" of the U.S.P.A.

Pete came to Lakemont and parked his camper truck in our yard. He was in trouble. He had wrecked his truck and was waiting on an insurance settlement. His wife had left him and had taken their son, Eddy, with her to New Orleans. She was working in a restaurant there.

Peter was vastly overweight and very much out of condition. His cooking might have been all right in restaurants, but it was entirely too "gourmet." My digestion just couldn't handle it, so Sarah resumed preparing meals for us, and we worked two or more hours later at night to make up for the time it took to prepare food for us. We did tests on projects I had been waiting over five years to finish.

Sarah became an excellent operator of my instruments. She was always interested in my research work—always enthusiastic and ready to work.

She was very kind to children. When Pete's wife sent their little boy back to Columbus, Ohio, to their old home to stay with a neighbor, and he was not in school, Sarah asked me if I would let him come here so he could be with his father and go to school. She knew the child was upset and disturbed over his parents' problems and their separation. She said that in such situations her sympathy was always with the children whose lives were all upset by their parents' immature behavior and lack of love and understanding. She had raised four children of her own and had helped rear two others, so I deferred to her judgement and let Peter bring the little boy here. Eddy did very well in the little country school and apparently enjoyed it. Of course it was very different from big city schools and the children he met were not the rough and tough characters such as he dreaded in the big city school.

I began working with the concepts and information gained through the successful experiment I did in 1931—that of bringing solar energy down a wire into a dark basement. I grew plants with Chlorophyll in the dark. I made designs and, by the end of 1980, I had a working model of a device that later I called my "Cosmic Pipe," using a 4-inch-round pipe as a housing (and also to utilize the form-energy of the shape of the pipe). Over the next two years we built and tested these all over the South.

We had successfully miniaturized my instruments, changing from vacuum

tubes to transistors. One of my greatest problems was the inconsistency of the energy values of transistors I found on the market.

Most of these were made in Japan or Korea. Their values varied greatly. Many of them were doped with arsenic and other poisons. Testing these proved very time consuming, but it was necessary, so we did it. We discarded many of the transistors and other components we had purchased, since we dared not use poisonous components in my Analyzer-Treatment Instruments.

At this time (80-88), I was building and testing computer circuits and trying to mate these to the ideas of measuring Eloptic energy, with the hope that this might turn out to be the ultimate transducer design I had been working for so long to attain. I thought it likely, though I knew from past work that Eloptic, or the basic energy of everything, is not electricity, but can ride on electricity. Also Eloptic energy is not optics, or light, though it is carried on light. Light of any color cannot be used in the Instrument to affect conditions, but if the energy of the Light is charged into a vial of distilled water, then the energy of the colored light may be used to treat out conditions inimical to the human body, plants and animals.

In my research of the potential of computer circuits, I was interested in observing the effect the constant miniaturization exerted on the effect of the energy of the material used in the components.

This observation gave me some ideas about the uses of these miniaturized components. After some study and research, I discarded these ideas, because of several ipso facto reasons:

1. Testing the energy of such components built into the schematic of my instruments. The main fact that emerged from these tests was that the general vitality or 9-49 of humans, plants and animals was affected unfavorably, lowering the subject's vitality to a great degree, while values for carcinoma, sarcoma, leukemia and tuberculosis were raised to an unbelievable extent.

I observed this phenomena over a period of seven years of consistent testing of specimens. Laboratory animals developed cancer, lung and nerve degeneration from treatment by instruments containing computer circuits. A friend who did such tests on laboratory animals collaborated on these tests with me in 1984 to 1987 and gave me full records of his tests, and results of my treatment of groups of mice and rabbits in his laboratory.

For that reason, I do not build computer type instruments, and I cannot conscientiously endorse any that are on the market today. Of all I have observed, the Digitron, built by Bill Lawson, formerly of Arizona, now living in Texas, is the least dangerous to human, animal and plant tissue and vitality.

The Story of Eloptic Energy

In my opinion, consistent use of computerized instruments is like playing Russian Roulette with a loaded gun. Most of these are built by amateurs in the field, who want only to build a salable device so they can cash in on the present interest in Eloptic energy (and so-called psychotronics), and couldn't care less about the effects on the human beings who buy and use these devices to treat themselves.

In 1981, Sarah and I began an experiment to see if we could affect the genes of a big white oak tree in our yard. We tested and chose a large paper shell pecan which had great vitality. It was a large, long nut, with distinct pecan-type markings and a very thin shell, with a sharp point at one end.

After testing the vitality and the effect of the energy of the pecan on the white oak tree, we chose to affect with the pecan energy, and record these findings. I set up a low-energy treatment instrument and began a long treatment period of the oak tree, using some of the cambium bark of the white oak tree as a specimen of the tree. We charged a vial of distilled water with the pecan energy and intensified it several times. Then we charged the energy of the cambium layer bark into a vial of water, and began a long period of treatment of the white oak tree with the pecan energy. We checked the vitality of the tree from time to time and measured the effect of the pecan energy on it, and recorded the results of these tests.

The oak tree was 35 feet tall and possibly thirty or more years old.

The original acorns had been round and very bitter. The next fall we noticed a trend toward length instead of roundness with all the acorns of the tree we could find. The squirrels took so many of them for their winter food supply. What the squirrels didn't take, the chipmunks gathered from those fallen on the ground. We had to get up early to get any of these for our tests.

Sarah had been involved in doing some hybridizing in the past, involving crossing hibiscus plant varieties with wild varieties of mallows, for color, form and herbal energies, using the orthodox methods. She had also treated with the instrument various non-related bulbs with each other's energy, with a wild variety of results. One of these was an experiment in which she used the instrument to bombard a helpless onion bulb with the energy of a yellow gladiola corm. After a 2-month period of inactivity caused by shock, no doubt, the onion grew rapidly and wildly, reaching a height of over 3 feet tall, and growing in a distinct gladiola leaves pattern, though the leaves were limp, and required staking.

These early attempts at genetic engineering of plants were just an exploration to see what possibilities such methods presented, and not to prove or disprove a theory. At present we are beginning a Transmutation test on seedling citrus trees and seedling white oak trees with the purpose of finding a method of eliminating the

time required to hybridize plants, by implanting in the genes of the plant with the most desirable traits, more desirable traits of an alike or opposite plant. We have done tests, with the result of gathering sufficient evidence that the test seed or plants may have additional beneficial traits impinged on their genes, and undesirable traits treated out (eliminated by treatment with the Eloptic Energy Analyzer). This type of research and development is a specialized field of research in itself, and needs the full attention of a dedicated Eloptic Scientist who wishes his work to be of great and unique benefit to the human race.

This can be developed to produce citrus, apple, plum, pecan, grapes, etc., without the several years of time it takes to produce seedlings, cut and graft individual plants by the thousands, and wait at least 5 years to grow producing trees and vines.

Among other things, we did some work in attempting to find successful treatments for diseases of the pancreas and liver.

We had one project in regeneration of the pancreas and the liver, especially in diabetic conditions, since we became interested in documenting the after-effects of Radiation Therapy. We had been very successful in finding substances for use in neutralizing cancer. In our inquiry into the effects of Radiation (cobalt and Chemotherapy), we found out of 100 specimens of people who had undergone these therapies, evidence of liver, pancreas, spleen, and gall bladder damage, ranging from middle degree radiation burns, with corresponding problems in organ functions.

Our work with AIDS was based on working with the energies of the AIDS virus, using enlarged photos of the AIDS virus obtained from Government Agencies concerned with Public Health. Since we did not have live specimens to work with (except in one instance a virus photo and 1 specimen supplied to us by a former Research Associate), we ran many tests involving the energy of the AIDS viruses charged into vials of distilled water, in at least 15 intensities, ranging from low to very high readings of the intensities of the disease.

These we measured, and used, in at least 100 experiments treating with various reagents which tended to build up the immune systems and reduce the vitality of the AIDS virus. This is an ongoing project, with the purpose of putting together an ongoing program of eliminating causes such as metallic poisoning, radiation damages, antigens and nicotine intensities, encephalitic damages to nerves, adding vitamin and mineral energies, nutritional aids, eliminating hormone imbalances, and regeneration of the immune system.

Our experiments were based on the theory we have proven to our satisfaction,

The Story of Eloptic Energy

that germs do not cause disease, but are scavengers, attracted by weakness and feeding on toxins generated in such weak areas.

We are still doing some advanced projects in these areas.

In 1984, for the first time, we showed our Cosmic Pipe at the Western Psychotronics Association in Denver, along with our other instruments.

You notice I say "Our Pipe" and "Our Instruments." I do this because Sarah was not only my wife in every sense of the word, but also she had become my partner in all our activities. We had shared our work, our fun, our experimental projects, and our agricultural and health research.

This agricultural work was based on what I learned in Pennsylvania and Florida in the 1950s and 1960s, when I had eliminated Gypsy moth worms, army worms, fungus, nematodes, corn borer worms, corn ear worms, tent caterpillars, tomato mosaic disease, lime tree disease, yellow palm disease, squash larvae, Mexican potato beetles, citrus and peach tree scale, and many other pests.

This time we studied and devised soil tests, water contaminants elimination, methods of cleaning feed, measuring and enhancing the vitality of field crops and vegetables, and elimination of animal, plant, and tree diseases.

Our first Cosmic Pipe customer was Eugene "Whitey" Kurkowski, of Grant, Nebraska, to whom we are indebted for some spectacular results with wheat seed energy intensification. He has since done some very good work with Eloptic Energy projects in connection with his two 80-acre wheat fields.

In October 1984, we had had a pitiful letter from a fellow from Texas whom we had met in 1981 in Florida. He had stopped by to see us in late 1981. He had been working for our friend Jane. We heard later he had been dismissed from his job with our friend, but she never discussed this with us, so we didn't know why. I only wish she had told us the facts about what had happened. It would have saved us a lot of trouble.

The man wanted a job. At that time we had only one employee. Sarah and I both worked all the time, sometimes doing our laboratory work in the evenings until late at night. We were still doing tests on the potentials of the Cosmic Pipe.

We discussed the situation and decided to hire the man. He wrote that he was broke. His wife had filed for divorce. The bank had repossessed his car, and he wanted to leave Texas. We offered him \$100 per week, and a place to stay as our guest. He came to Lakemont and began to work for us. He knew very little about our work, so we had to teach him the basic information.

We paid for a business booth at the Acres U.S.A. conference that November to promote the use of our Cosmic Pipe. The three of us attended the conference and sold

1980 - 1988

a few pipes, and instruments, which gave us some cash to work with.

In January a couple from the Midwest spent a few days with us, learning to use the instrument and the Cosmic Pipe. They became sales people for us. We were advertising in Acres, U.S.A., at that time. In order to get out all the orders in time, we hired two young men. One was a local man who had just finished his enlistment term in the Air Force. The other was a veteran who was a second year student in electronics at the Northeast Georgia Technical School.

He worked from 4 PM until 11 PM in the shop. The other man worked from 8 AM until 4 PM. Both of these men were intelligent, quick to learn and honest.

This gave us four employees, and we began to learn about the Labor Department of Georgia. We hired three more, one to do lab work, and another man and a girl to work in the shop. I learned about employees from these three! I fired the girl when I told her to build a Tesla Coil for me, and she couldn't do it. Then I found out her brother and the young man I had hired were doing her work for her, so she could collect her pay. Her brother was angry because we fired her, and built our anapathic instrument with a shortened wire, so that metal fatigue, as the knob moved with scanning, would break the wire and ruin the instrument after a research associate had already begun to use it. He became quite impertinent, and put up an obscene sign in the shop's assembly room. His wife, who worked in our lab, was doing unsatisfactory work. Sarah got tired of the situation and dismissed them without notice. Then she waited for them to try to collect unemployment insurance. The sister who I fired for incompetence, filed a claim, but didn't pursue it since I listed the cause of dismissal as incompetence on the job. The other two probably figured we had enough against them and enough witnesses that it wouldn't be worth their trouble to apply. So I learned about employees from them.

The fellow from Texas seemed willing to work and had a lot of enthusiasm. He was tall, with red hair, and wore a grin. His education, though patchy as to consistency, was fair. I inquired privately into his background and was amazed to learn he had been divorced twice and had been fired from almost every job he had ever held. Of course I wondered why, and concluded to keep an eye on him continually. I had a premonition that he would eventually prove to be more dishonest than K. I should have paid heed to that premonition.

Later on, I found out he was the fellow who "liberated" two tons of Micro-min (an alluvial clay very useful to farmers) from John Scott, who lived near Crescent City, FL, and took it home to Texas with him. If I had known that, he would never have been associated with us, regardless of the "energy" he claimed to put into our business.

The Story of Eloptic Energy

One of my surprises was that after he met the mother of one of our shop technicians, he seemed to live without much sleep. They were the scandal of the neighborhood with their intimate relationship.

We raised his pay and still let him use our mobile home to live in. Finally, on his demand for "more money," Sarah laughed and told him to get married. Much to our surprise, he and his live-in girl friend made plans to do so. They had two ceremonies, one civil, at an Oconee County, South Carolina, Judge's office, and the spiritual ceremony at a beautiful big waterfall not far from Lakemont. Sarah performed the ceremony and Judge Leisher and I participated in it. We hoped marriage would settle him down somewhat and let him put his attention more on his work.

We hired another man whom we had tried to help with our experimental cancer projects. He had asked us to use him as a subject of one of these projects, which we did. Our work in this area got him out of bed and on his feet again. He said we saved his life with our Eloptic Energy methods. He also had worked for our friend Jane. Later we found he had been dismissed from her employ for sheer hypocrisy and lying, and had been caught in the act.

His agricultural knowledge was thorough, but like the other man's education, was behind times and out of date.

I should have fired both these people immediately when I found out their backgrounds, but I hoped they would change and use their opportunity with us to learn and become better people.

Being married didn't help our Texas friend's personality. He became more arrogant, told more lies, and didn't take much interest in his work. We were paying him at that time more than the going rate in this area for such work, and gave him a \$2,000 bonus at Christmas in 1985 for his past good work.

We found out in January 1986 that he and his wife, whom we had taught to operate our instruments, were doing soil, water and food tests for our customers for pay, and had not told us about it. Then we had phone calls of such a nature that we were forced to accept that he, and a research associate of ours from Connecticut, had sold our equipment to farmers in South Georgia—after the Southeast Exposition in Moltrie, GA, the past October—and had not turned in the money to our bookkeeper and secretary, who had been with us several years, and whose loyalty and honesty had been proven many times.

We were going to Florida at the end of January on a combined business and vacation trip. At that time, he gave us a note demanding \$20,000 a year, plus a weekly bonus. I told Sarah to lay him off a few weeks, and we would talk to him when we returned. The upshot of it was that he never came back to talk to us. He came here

only when we were gone. At our Conference at Ole Clayton Inn, the last of February, he arranged a meeting with our customers and associates, and approached one of them with a proposal that he should finance a business to build our instruments and duplicate our work. We became aware of the fact that he had gotten into our files and helped himself to a great deal of information. We investigated the legal aspects of this. When he began advertising a device he built for sale (one of which was sent to us by a friend, one of whose customers had purchased one), we were amazed to find the device was built on our principles and using our components, but we shouldn't have been, since he stole all his information out of our files.

Since then, he and his friend, our former Research Associate from Connecticut, have completed a whole set of devices using our techniques. One of these devices is an instrument using a 360° dial. We tested such a configuration twice. Once when we used vacuum tubes, and once after we miniaturized our instruments using transistors. Using all our knowledge of the natural laws of Eloptic Energy, we found that the rays emitted from the lower half of the dial are dangerous, the energies of enhancing the energies of all such diseases as cancer, kidney malfunctioning, fibrosis, and nerve disease. These tests gave us much information, so we concluded that such devices are dangerous, and over a period of years, we saw disease, disability, and death of all treated with this type of instrument. So we twice tested and discarded this 360° dial and do not use it in any of our instruments.

Our research is aimed at finding methods to enhance health of people, animals, plants and soils, rather than to build devices for sale just for the money we can acquire in that manner, regardless of the automatic damages that can be done to people by the use of such devices.

Of course the lies this fellow and our former research associate have told to our associates all over the Midwest have marked them for what they have shown themselves to be.

One of these lies concerned a situation caused by one of our shop technicians, an ignorant fellow, and the other employee whose life we saved with our research work in cancer.

Sarah and I had noticed for over seven years that farming with the use of deadly chemicals was extremely dangerous to humans. Many times there were accidental spills which drenched the person handling the chemicals, thoroughly soaking his clothing, resulting in skin burns and breathing in of deadly fumes. We began a program of researching effects of seven typical farm herbicides and pesticides in 1981. Thus began our immunity research. We continued this research by seeking and finding various substances, such as nutritional supplements, energy substances,

The Story of Eloptic Energy

hormones, etc., that would cancel out the result of these substances. We found these to be few and far between, but over the years between 1981 and 1986, we found a few substances whose ability to cancel out the effects of chemicals undeniably existed.

Hugh Lovel, who became one of our research associates in the winter of 1985, introduced us to Bio-Dynamic Compost-building substances, as pioneered by Dr. Rudolph Steiner in the 1920s era, and we found 2 of these to be very helpful in combating the adverse effects of chemicals on the human body. Here we went back to our AIDS research and the work we had done to document methods of treating the central nervous system, vascular system, skeletal structure, gastro-intestinal system, elimination systems, and endocrine systems of the human body to enhance the strength of the genetic blueprint and the auto-immune systems of the human body. Thus we worked with both these parallel areas of research at once.

However, by the summer of 1986, we had progressed to the point we could see something of the results we were searching for.

We had treated ourselves and those people of our staff, who had given their permission, with several vitality enhancing substances over a period of two years. When we went to Denver in 1986, to fulfill our lecture obligation there, we left one treatment, a test of our combination reagent, in which the poison was counter balanced and cancelled by the 3 substances we had found were more positive in effect on human vitality than the negative effect of the chemical poison. We left a specimen being treated in the lab, with our reagent charged with protective energy, a specimen of the subject with us and checked it with our portable instrument twice a day. If we had found any deleterious effects at any time, I would have phoned our secretary, Jimmie, immediately to terminate the experiment by removing the specimen from the well, and turning off the power. We did not find the reagent to be at all dangerous to the subject.

When we returned from our trip and tested the effects on the specimen, we found something had interfered with the test, and we had to start all over again with the experiment.

We found out later that one of the shop employees, a son of the woman our Texas man had married, had gone into the lab, noticed whose specimen was in the well of the treatment instrument, took out the reagent, opened it, and called our employee (who had acknowledged that we had saved him from dying from cancer), and together tried to analyze the reagent, at which process they had very little skill and knowledge, and damaged the experiment beyond use. The shop man quit his job here before we returned, giving his resignation to Jimmie. The other man and his wife, whom I had been forced to warn to stay away from people who were not

1980 - 1988

friendly to us, were spending hours every evening with the Texas man, carrying gossip and helping him use the incomplete information he had stolen from our files. I told Sarah to terminate his employment and tell him to take his mobile home off my land. I do not have to tolerate hypocrisy, lies, disloyalty and lack of application to the work I pay an employee for performing.

So he became angry and accused Sarah of trying to kill the person whose specimen was in the well of the instrument when he and the shop employee interfered and ruined the experiment. We had used the employees, with their permission, during the active testing of the chemical-cancelling reagent we had made, doing all our preliminary work treating and testing the effects of the chemicals by using vials of water into which the energies of the chemicals had been charged, and checking the effects of reagents on the chemical's energy in the vials of water.

So the fellow who kept saying he was so grateful to us for saving his life, ruined an experiment which had taken months to do, and interfered in our chemical immunity project, when we were just almost ready to give the results to our research associates to use in their documenting the results in chemical accidents and spills.

When he was fired from here, he joined his thieving friend from Texas in telling the biggest lie of all, that Sarah tried to kill him with an instrument.

I can truthfully say this: an instrument could be used to harm someone, I am sure, just as an automobile can, but our work has always been constructive in purpose and accomplishment. Sandy Asbill (Texas) and George Gibbs (cancer research subject) and Donald Mattioda (former Research Associate) will reap the rewards of their stealing and lying, and their ingratitude to Sarah and me (who always helped them instead of hurting them), just as Kelly did when the FDA forbade him to sell the books containing the proprietary information he plagiarized from my copyrighted material. This is a law of the Universe, and works invariably to the detriment of the thief, the liar, and the hypocrite, and the egotist. We will not have to lift a finger to do anything to accomplish this, since it is a natural universal law.

I also point out that my wife, Sarah, has helped many people. Some are alive today only because of her compassion and willingness to spend her time to use her knowledge and skill to save their lives.

No one has treated her and me so cruelly, so dishonestly, and so falsely as these three men have. We regret that we ever allowed them to be here.

So we learned about employees and associates from them!

I am thankful that all employees are not like the ones I have cited here, we would never get any work done if that had been the case. We have had some very good,

The Story of Eloptic Energy

truthful, and loyal employees during these years.

Jimmie, our secretary will have been with us five years in February. I do not worry about his integrity, honesty and loyalty since I know by experience that he has all of those sterling qualities. Alan left a very remunerative job with a large electronic company in early 1986 to work with us. I have found him to be completely trustworthy. Mike, who worked for us in the shop for over a year, was a student at North Georgia Tech, about sixteen miles from here, during the weekdays, and worked in our shop from 4-11 p.m. daily. His work was excellent in quality. If I asked him to do anything for me, he did it cheerfully, willingly, and correctly, just like Jimmie and Alan do.

So I have learned from these men about employees.

Besides these positive inputs, I have confidence in all our many Research and Sales Associates across this country, Canada, and in some foreign countries. In my opinion, there is nothing so disgusting as the scientist who sets up his research work to prove that his own theory is right and all others are wrong. I have encountered very little of that among scientists working on the frontiers of esoteric sciences, and our own Research Associates.

The moral contamination today seems to exist among Egos, who work for money and fame, and do not mind falsifying research data to accomplish their goals.

My years since late 1979 have been very happy and filled with achievement in spite of all the hardships and the work of making "bricks without straw" or carrying on a business with small working capital. We have literally pulled ourselves up by our bootstraps, as the old saying goes.

I realize now that I may not be here much longer. I will be 92 on my birthday in 1987, a few months from now. My strength is less than I had last year, but my mind is still keen. I have over twenty projects begun, and we are working to complete as many of these as possible.

When it is my time to leave this physical world, I am ready to go. I have completed my arrangements for disposing of this physical body which has served me well during my sojourn in this world, and I have Sarah's pledge that she will see that my wishes are obeyed.

One thing I want to say here: If any "channel" ever tells you that he or she has received a message from T. Galen Hieronymus, in-spirit, disregard it completely. It is a lie. I will never be sending any messages through any so-called sensitives or channels. If such a message is called to your attention, you can rest assured it is given by a lying spirit seeking to deceive. I have not trusted "channels" in this world since 1983. Most of such work today cannot meet the challenge: "Is it truthful? Is it harmful

to anyone? Does it contain enough facts to be verified? Is it designed to scare people?"

My wife is the only channel I can find whose work has always met that challenge. My plan and my commitment is to return to physical body in this world as fast as possible, for I still have much work to be done and much research to pursue in order to establish the work I have spent this lifetime to accomplish, as a viable common knowledge and accepted practice. It is my intense goal. All my plans are already made to achieve this goal in the not too distant future.

I caution you also, that many people will say they worked with me in my research. This also will be untrue, so do not believe it. My beloved wife, Sarah, has been my only research partner in the last nine years, since May, 1979.

Louise, my wife for 48 years, was my research partner from 1934 through 1972, when she became ill and could not continue to work with me.

In the late 1970s, I worked a month in New Hampshire, studying the Spruce Bud worm infestation in the Spruce Forests. Dave Waddell was associated with this study. In my earliest days, I studied the emanation patterns of mineral elements' energies. Stanley Rogers worked with me in studying this phenomena. So be warned: if anyone tells you he worked with me in my research work, he is telling you a lie. There is not a word of truth in such a statement.

Here, I pause to give credit to many independent researchers who use my equipment, and who carry The Research Associate Card from Advanced Sciences R & D Corporation. We serve as Consultants to these people, and share our expertise and experimental experience with them upon request, while they share also with us the information they have gained in individual research of subjects of common interest both to them and to us.

Of all the people I have come in contact with over the years, I say thanks for friendly, interesting and helpful friends. To: Tak Kidochi, Dean Stonier, Eugene Kurkowski, Darlean Moreland, Jeffrey Smith, Preston Nichols, Haroldine, J. Paul Jones, George Meek, Robert Beutlich, Nathan Babcock, David Prater, Gene and Arlene Litwiller, Don Bohler, Ronald and Pat Schultz, John Albright, Chief Two-Trees, Wayne and Diane Harrod, Joe and Virginia Falcone, Leroy and Theresa Shartz, Rev. Wayne Taylor, Melvin and Shirley Ereb and Jim Demmitt and all their friends in the heartland of America, Jane Pedrick, Bill and Vivian Tisher, Dr. George Douglas, Dr. Dean Howell, Dr. Robert Beck, Ph.d., Stanley Sobel, Ken and "Liz" Miller, Warren Williams, Lana Moore Williams, Martha and Bill Bussey, Dr. George King, M.D., Dr. Don Cornelius, Mrs. Louise Coldren, Patrick Marcellino, Glenda Schmidt, Hugh Lovell, Jerry Hedges, Mark Moeller, Dr. Richard Vail, Dan and Marie

The Story of Eloptic Energy

Murray, Dave Waddell, Joshua and Judith Ross—and the list could be longer.

One last caution: If anyone tells you he or she worked as my "Research Associate" over a period of years, ask him or her to show you the "Research Associate Card of Advanced Sciences R&D Corporation, signed by me as President, and by Sarah, as Secretary/Treasurer, of the Corporation. That is one way to positively identify our Research Associates.

Of People and Places

One of the great joys of living is to meet friendly interesting and interested people. The 1980s brought us many of these.

Jane Langford was one of those who became a special friend. Her farm, "Precious Little Farm," near DeLand, Florida, became a testing ground for us. We treated Citrus Scale and other diseases out of the orange grove, treated the hay fields with a Geranium juice reagent (while working on the proper combination for the Reagent) so that the fall army worms left it in great droves, treated one spot successfully to get rid of nematodes, carried on Cosmic Pipe tests there, enjoyed some of the most delicious organically grown citrus fruit we had ever tasted, and spent some relaxed pleasant days there.

One of our more interesting experiments was begun to find the cause of the hives from which Sherry, a friend of Jane's, was suffering. The odd thing about Sherry's illness was that the manifestation began with a slight itch in a skin location, which became a raised wheal on the skin. Then another and another such itching raised wheal would appear, until Sherry was in such agony she would go into a coma.

Taken to the hospital emergency department, she would be given sedatives, carminatives, etc., and remain in the hospital until the condition disappeared, only to appear again after a short time. She had been to the State University hospital for tests, which revealed allergies, but got no results so far as healing the situation was concerned. She had been to a famous clinic, but to no avail.

We analyzed the situation with our equipment, and found that the chlorine in the city water was the culprit causing the outbreak of hives. We treated the excess chlorine out of her system, and she began drinking spring water, with no more hives and allergies.

We found a similar situation later. A nurse in Long Island, New York, sent us a picture of her cat, Bosco. Bosco was a handsome Chocolate Point Siamese cat.

His owner was quite concerned that Bosco was having "Jacksonian" seizures. He often ran round and round, frantically clawing at his back. He did not froth at the

mouth, but could not remain still. With the Eloptic Energy Analyzer we checked Bosco for allergies, and found that Chlorine was the culprit. We treated out the Chlorine, and warned his owner to buy spring water for Bosco.

At this time we engaged in an interesting project with the Eloptic Energy Instrument. We monitored an interesting operation by a prominent surgeon, which took place in a large university hospital. A friend who was there with the patient phoned us as the patient was being taken into the operating room. By monitoring her vitality with the Eloptic Analyzer, we knew when the Anesthetic was given, and when the abdomen of the patient was opened. At that minute, our instrument registered an abrupt rise in the Strep and Staph count intensity. We treated the patient for a sudden hemorrhage and checked her condition ten times per day during her recovery period. One day in scanning her condition with our instrument, we were amazed to find a high intensity of food poisoning. This presented a puzzle. How could a person on intravenous feeding get food poisoning?

About that time her friend phoned to say the patient was sick with all the symptoms of food poisoning. I told her to check the intravenous feeding bag. She phoned back later that day to tell us that she had checked the intravenous device's food bag, and it contained the liquid food in a spoiled, rancid condition. She left it as it was, sought and obtained an appointment with the surgeon and told him about the spoiled solution in the feeding device. He didn't believe her, so he went to the patient's room to see for himself what was the trouble. He found it just as she had described it. The nurse's aide had not changed the bag for several days, and continually poured the new "chicken soup" into an already contaminated bag. Needless to say, the surgeon created a great understanding of necessary sanitary precautions among the nurses and nurse's aides, and it did not happen again.

We attended several conferences during this time, and were speakers at most of them. As I recall, there was the 1981 U.S.P.A. conference in Dayton, Ohio, at which I was the Keynote Speaker. My Keynote Address didn't go too well with the leaders of the group. I had observed several things happening which as Scout Executives, Commissioners, and Scout Masters, working with thousands of Scouts, we had always tried to eliminate.

These were: (1) Perpetuation in office and on the board, over and over, of a certain group of people; (2) A lack of a sense of responsibility among officers, board members, and committee members, an atmosphere of "let George do it." I had not seen anything dishonest, only a shirking of responsibility, a lackadaisical attitude toward the organization on the part of those who tended to perpetuate themselves in office. Then there was the situation of a board member and officer, who being

The Story of Eloptic Energy

allowed to use my Copyrighted (1976) Rate Book, copied it, rearranged it, and published it as his own, at the same time beating the drums to his loud cry that he was a student of Dr. T. Galen Hieronymus. This was patently a lie, since he had come to us to do the chores and the cooking. He was too obese to do many chores, and my digestion couldn't stand his cooking. He was in trouble financially, his wife had left him, and so on and on. I would have asked him to leave, but we had allowed him to bring his small son here and enroll him in school, and we would not hurt the child.

All this is what I had in mind when I told the Conference, in my Keynote Address, that it was high time to do a thorough housecleaning of the U.S.P.A., beginning with the Board and the Officers!

We began publishing the Advanced Sciences Advisory in 1981, beginning with light pages in the first few editions. We enlarged the publication, made it half letter-page size, and published science-frontier subject papers by many amateur authors, as well as our own papers.

Since the U.S.P.A. Board and Officers, who continued to perpetuate themselves in office, paid no attention to my Keynote Address, we did editorials about the situation of the Board Member and officer who plagiarized my copyrighted rate book, until we were accused of trying to destroy the U.S.P.A.

My attitude was that the U.S.P.A. was operating under a disadvantage of having a dishonest man on its Board and as an Officer. The U.S.P.A. needed a housecleaning, a purgative action, to cleanse itself of dishonesty and a thief on the Board, and list of Officers, to say nothing of not enough delegation of authority, not enough committee work, and continual perpetuation of the same people in office—all signs of internal decay of an organization.

I was a Charter Member, a Life Member of the Board, an elected "Veteran Director," but I came to the conclusion that since I had earned some National and International prestige for the research work I had done and the instruments I had developed, that any title the U.S.P.A. gave me was for the purpose of exploiting my name for their own purposes.

In 1983, I put together copies of Kelly's book and my copyrighted Rate Book, showing that he had copied even the mistakes in my book, and presented my paper after the 1983 conference at Portland, Oregon, in July. I waited and waited, and no word came for a long time from the Board of the U.S.P.A. as regards the request I made of them for justice, backed by evidence of Kelly's plagiarism of my book. Finally in September, I received a letter from the U.S.P.A. President, Henry Nagorka, excusing himself for the delay by saying he had been to Australia.

The message from the U.S.P.A. in reply to my presentation of the evidence of

Kelly's thievery of my copyrighted material was, "Boys, shake hands and forget your differences for the good of the U.S.P.A."

That did it! I had doubted for a long time the real motives of my so-called friends and fellow charter-members. Now I accepted fully their stand. I immediately wrote my resignation from membership in the U.S.P.A., from being a Life Member and Veteran Director on their Board. It was no honor to be affiliated with an organization which not only condoned thievery and dishonesty, but refused to accept the fact that the U.S.P.A. was rotten at the core.

I printed an announcement that I had resigned from the organization and had nothing whatever to do with it. This announcement I put on the 1st page of our Advanced Sciences Advisory, and have run it in every issue since 1983.

In 1982, the Denver Chapter, the largest group involved in membership in the U.S.P.A., hosted the U.S.P.A. meeting held in July at the Colorado School of mines.

For some reason, the U.S.P.A. rewarded their efforts by deciding to hold their 1983 meeting in Portland, Oregon, instead of meeting in Denver again. The Denver group decided to cancel their membership in the U.S.P.A. and have their own yearly conference. We were invited to speak at the conference, held at St. Regis College, Denver, in 1983, which we did. Dean Stonier and his group were very hospitable. We thoroughly enjoyed the Conference. After the conference, we were shown the sights of Denver, a delightful city, and taken by Dean and Phyllis to Central City, an old mining town in the mountains, where we were introduced to the breathless delights of "The Oh My God!" Road, a local phenomena.

We participated in the program of this wonderful Western Psychotronics Association for five successive years.

As the group grew and its interests became more cosmopolitan, the name was changed to Global Sciences Institute.

Last year, 1987, we did not participate in the program because we had already made commitments to attend the Eastern Acres Conference at Carlyle, Pennsylvania in August, just after the Global Sciences Conference in Denver, so we had to go there.

Altogether, counting the I AM conference at Stapleton Plaza in Denver, we participated in seven conference programs in Denver.

Advanced Sciences Research and Development Corporation was chartered in 1967, under the Laws of the State of Florida, while Louise and I still lived in Florida.

When Sarah and I began working together, I had set up the Corporation offices in my home in Lakemont, Georgia, and registered the Corporation under the Laws of the State of Georgia. Over the years since 1980, the Corporation's scope expanded. We established the Institute of Advanced Sciences to fulfill the Corporation's

The Story of Eloptic Energy

commitment to education. We offered a few correspondence courses and began work on putting together other courses, all concerned with teaching an understanding of Eloptic Energy, a term I had coined in the Office of the Patent Commissioner in Washington.

Our good friend Nancy Williamson, in Ft. Lauderdale, Florida, had helped finance my research for a number of years by a regular donation from her large income from her father's patents, which as a donation to Advanced Sciences Research and Development Corporation, Inc., a 501-C3 Non-Profit Corporation, enabled her to take it off her income tax return. Though her donation seemed large at first, inflation soon whittled it down. I had built and sold a few instruments over the years, and taught students how to use the instruments, but with the increase of inflation and increasing expenses of running the Corporation, it was necessary to build and sell instruments to finance the corporation's activities.

1980 - 1988



Dr. Hieronymus building roof over the patio of his home in 1981.



Dr. Sarah Hieronymus and Nadyne Reed in Lakemont, Georgia, in 1984.

The Story of Eloptic Energy

*Dean Stonier,
Dr. Hieronymus,
Bill Lawson,
Dr. Sarah Hieronymus
and Melva Lawson, at
Western Psychotronics
Association
at St. Regis College,
in Denver, Colorado,
in 1984.*



*Professor Sam Lentine,
Dr. Sarah Hieronymus,
and Jennie Wolff,
at Advanced Sciences
R&D Corporation
August 1984.*



1980 - 1988



*Dr. Hieronymus with Dr. Barry Ratner, and
Jerry Hodges (of Agnihotra Movement)
at Advanced Sciences in 1983.*

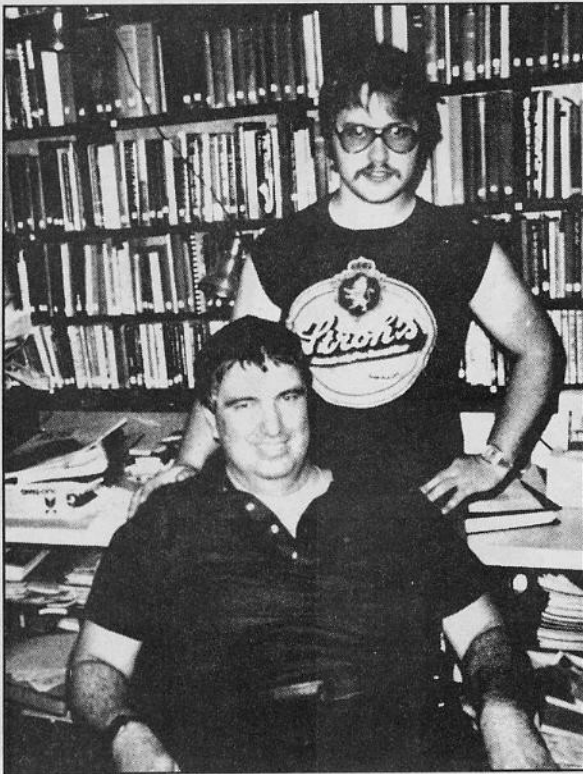

*Preston Nichols, Researcher par excellence, and
his Assistant, at Advanced Sciences R&D
Corporation, Lakemont, Georgia, in 1984.*

The Story of Eloptic Energy

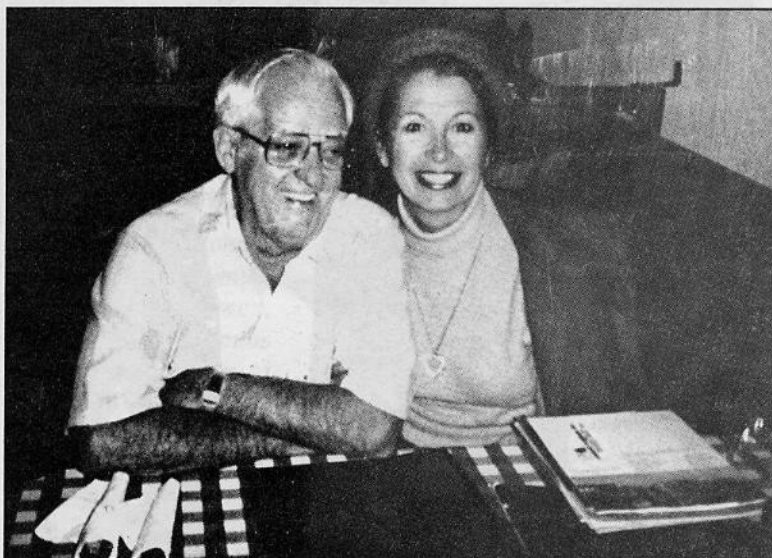

*Dr. William Brown and wife,
Maria Brown at ASR&D
Corporation office in 1984.*

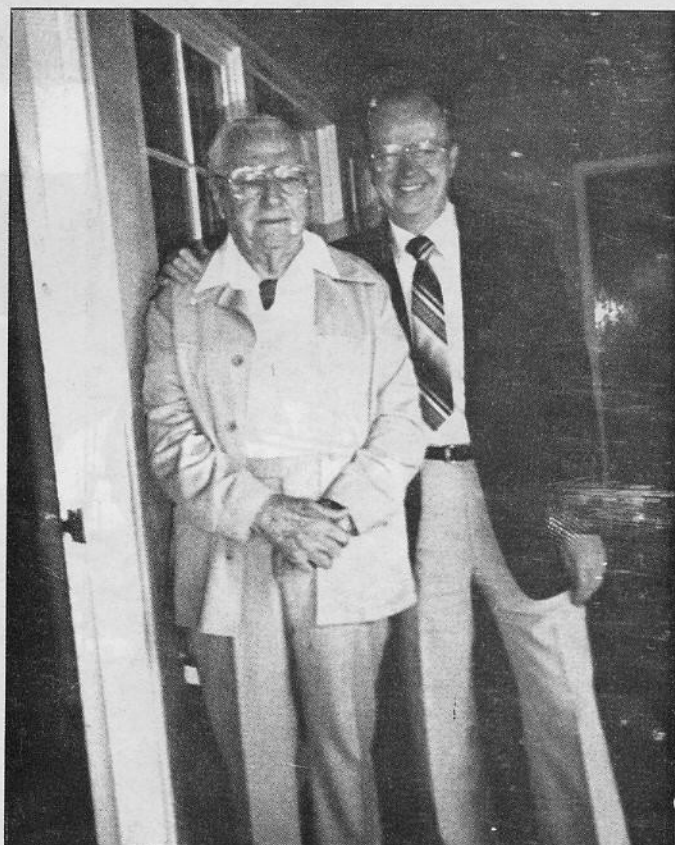

*Dr. Hieronymus and Stan Sobel in
San Diego, California, in 1984.*

1980 - 1988



Research Associate, Mark Moeller, (Pea Ridge, Arkansas) and Tac Kikuchi at Del Mar, California, examining tomato plants in 2500 acre tomato field being grown under Cosmic Pipe Energy in 1985.

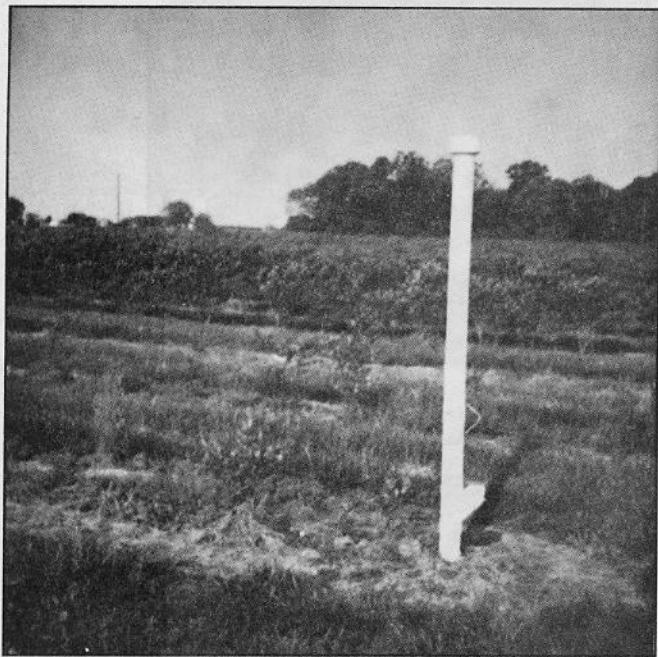

The Cosmic Pipe in Blueberry field in Arkansas in 1984.

The Story of Eloptic Energy



Dr. Hieronymus taking a water sample for testing from a pond in an Apple orchard in Habersham County, Georgia.



Daniel and Alan Mitzlaff installing Cosmic Pipe in Apple Orchard, 1986.

1980 - 1988



Kansas farmer admiring his Organic Wheat, grown with Cosmic Pipe energy without sodium fertilizers and chemicals.

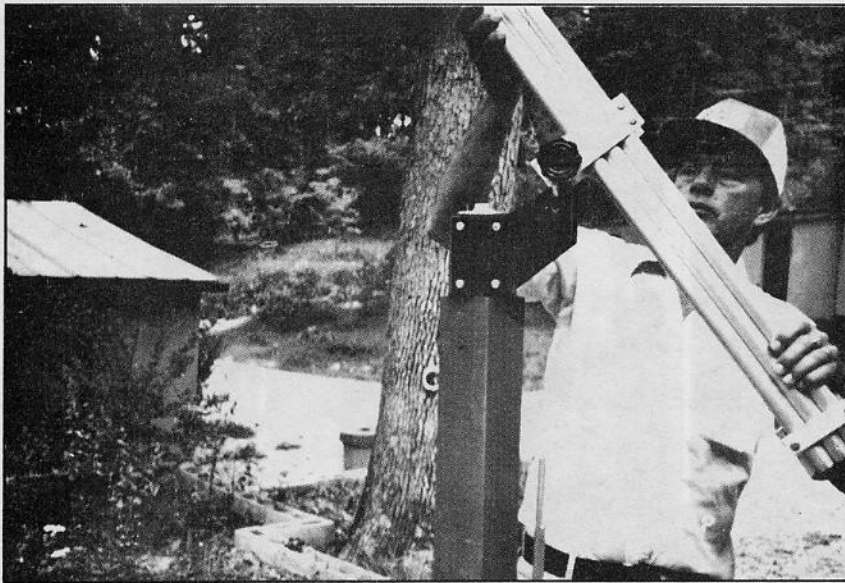

Alan Mitzlaff checking Cloud Buster designed by Dr. Hieronymus, and built by Alan and Dr. Hieronymus in 1987.

The Story of Eloptic Energy

Rolf (Rho Sigma) Schaffranke, Hilda Schaffranke, and Eric Ryder at 1st Annual Hieronymus Energy Conference, at Ole Clayton Inn, Clayton, Georgia, 1986.



Nathan Babcock, Research Associate of Advanced Sciences R&D Corporation and Mrs. Louise Coldren after installing a Hieronymus Cosmic Pipe on Mrs. Coldren's farm in Rabun County, Georgia, in 1987.

1980 - 1988



Dr.'s Galen and Sarah Hieronymus and group from MUFON Association and Energy Conference in Dallas, TX, in August 1986.

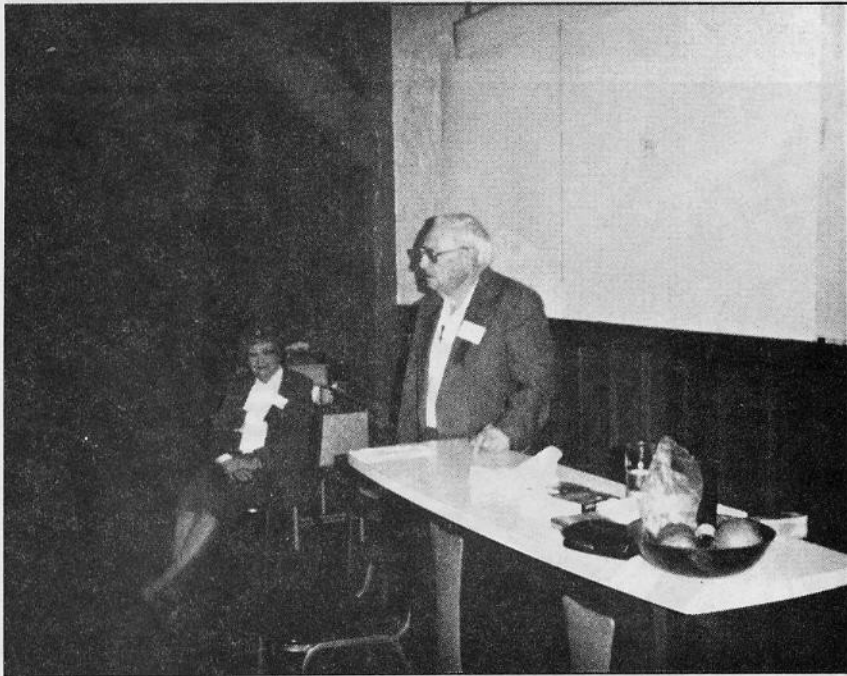

Dr. Galen Hieronymus addressing Hieronymus Energy Conference, Clayton, Georgia, January 1987.

The Story of Eloptic Energy

Samples of Wheat, 1987, from 2 Kansas Farms. The larger sample, larger seed pods, greater root system, grown without sodium fertilizers and chemical poisons, with the Hieronymus Cosmic Pipe. The smaller sample was grown on neighboring farm with sodium fertilizers, poisonous chemicals, and anhydrous ammonia.

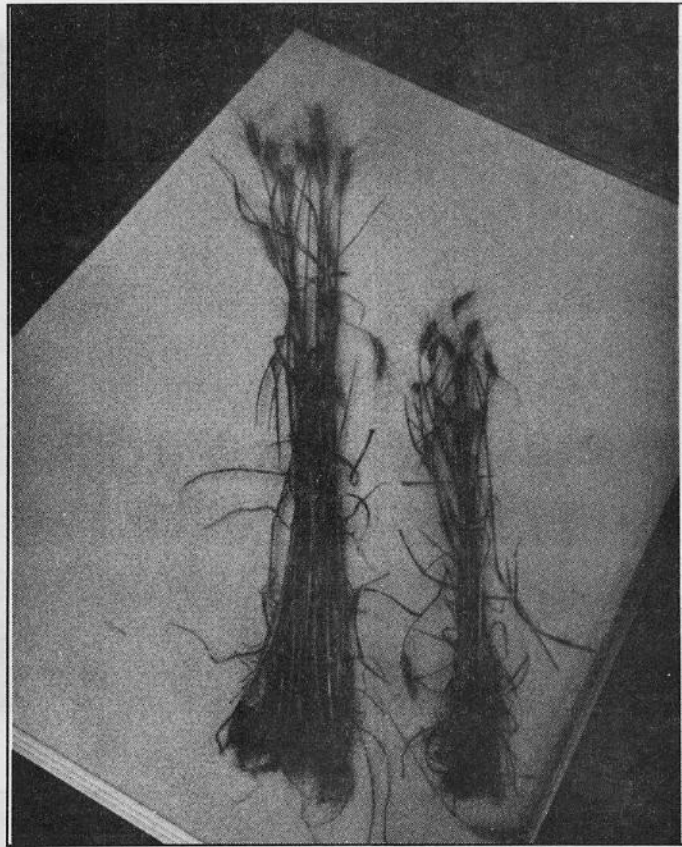

Dr.'s Sarah and Galen Hieronymus at Global Sciences Conference, Denver, Colorado, August 1986.



1980 - 1988

ADVANCED SCIENCES
RESEARCH and DEVELOPMENT CORPORATION, Inc.

Dr. T. Galen Hieronymus, Ph.D.
President

Dr. Sarah E. Hieronymus, Ph.D.
Secretary-Treasurer



P. O. Box 109
Lakemont, Georgia 30552
(404) 782-5347

GENUINE HIERONYMUS ANAPATHIC INSTRUMENT

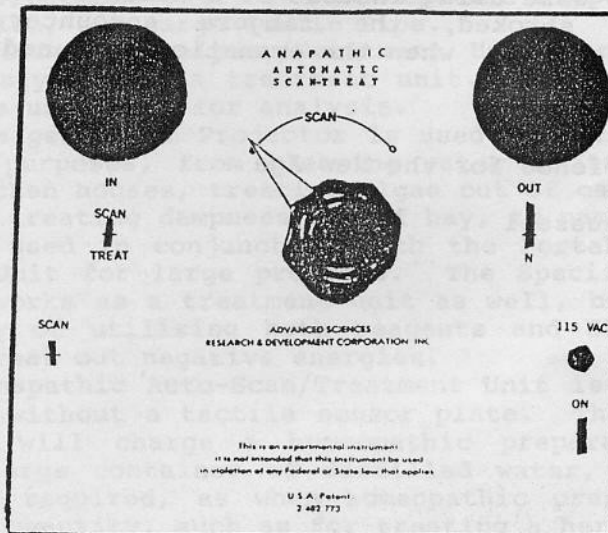

When you need results in a hurry, there is nothing like the results you get from a "Genuine Hieronymus" anapathic instrument. Take for instance, in the morning there may be a cow or two that needs attention. With an analyzer it would take a couple of hours, but with the anapathic, only minutes. Just put the specimen in and set it to scan. Within 35 seconds it is done. Turn to treat and set timer for 20 minutes. When the buzzer sounds, the job is completed. Then attend to the second one, within an hour you're done!

The farmer that has any number of livestock surely must look into having his own anapathic instrument. The savings alone on the vet bill could pay for the instrument in a very short time. Remember, this is a one time investment. Most farmers could well save 80% or 90% of their vet bills each year! How much money would you save? You know farming today is different. We must start looking for ways of spending what little money we do have just once. How many times have you waited to call the vet, then it took more than one service call to your farm? So many times if you would take care of the problem yet tonight, it would be better in the morning.

The Story of Eloptic Energy

Radionics owes its next great impetus to a pioneer of radio, Thomas Galen Hieronymus, formerly of Kansas City, who produced some ingenious instruments which used vacuum tubes for "amplification" and condensers, instead of resistances, for "tuning". To Hieronymus belongs the honor of being awarded one of the most unusual patents ever granted by the United States Patent Office. This patent - No. 2,482,773 granted in 1949 - describes an instrument for the 'detection of emanations from materials and measurement of the volumes thereof.' As a detector, it used a rubbing-plate, which, by this time, many were using instead of a human abdomen. When the plate is stroked, the fingers encounter tactile resistance or "a stick" when the emanation is tuned in.')

Excerpt from:

RADIONICS: A Science for the New Age

By: Edward W. Russell

1980 - 1988

ADVANCED SCIENCES R&D CORPORATION

Our Corporation currently produces eight Eloptic Energy Instruments. These include: The Portable Analyzer/Treatment Unit, The Small Portable Analyzer Unit, The Reagent Beam Projector, The Specific Rate Beam Projector, The Anapathic Auto-Scan/Treatment Unit, The Homeopathic Preparator, and a Small, Medium, and Large Cosmic Pipe.

The Portable Analyzer/Treatment Unit can be used as both an analyzer and a treatment unit. The Small Portable Analyzer is used only for analysis.

The Reagent Beam Projector is used as a treatment unit with many purposes, from cleaning water to treating odors out of chicken houses, treating algae out of cattle watering tanks, and treating dampness out of hay, to name only a few. It can be used in conjunction with the Portable Analyzer/Treatment Unit for large projects. The Specific Rate Beam Projector works as a treatment unit as well, but it has the flexibility of utilizing both reagents and Eloptic Energy Rates to treat out negative energies.

The Anapathic Auto-Scan/Treatment Unit is an automatic instrument without a tactile sensor plate. The Homeopathic Preparator will charge a homeopathic preparation into a small or large container of distilled water, depending on the dosage required, as when homeopathic preparations are desired in quantity, such as for treating a herd of cattle.

The Cosmic Pipe is designed to balance the soil, with an abundance of solar and planetary energies picked up at the accumulator in the top of the pipe, modulated by energies needed by the plants, and broadcast underground into the soil to aid the plants in their transmutation of elements into what they feed upon. It is not necessary to use fertilizers when the pipe is used.

All of our instruments and pipes that we sell are sold with the purpose that they be used for experimental use in research to improve the quality of life and health of plants and animals. Being experimental in nature, it is not intended that they be used in violation of any Federal or State law that applies.

The Story of Eloptic Energy

THE INSTITUTE OF ADVANCED SCIENCES HOME STUDY COURSES

Our Home Study Course in Basic Development of Sensitivity is now available to students. This course is a prerequisite to all of the other courses that we offer except Science of Eloptic Energy.

Basic Development in Sensitivity covers the sensitizing of the senses used in everyday work and learning. In order to use present day Eloptic Energy equipment, hands and the sense of touch should be developed to be efficient. The excercises and practices outlined in this course are designed to do exactly that. There are twelve lessons and practice outlines in this course. For more information on this and other courses we offer, write to: Institute of Advanced Sciences, P.O. Box 109, Lakemont, GA 30552.

ELOPTIC INFORMATION ENCYCLOPEDIAS

Advanced Sciences R&D is pleased to announce that it has for sale a set of Encyclopedias consisting of the following 11 books:

1. Dr. T.G. Hieronymus & Advanced Sciences Research and Development Corporation, Inc.\$25.00
 2. General Information\$15.00
 3. UKACO Project Information\$ 7.50
 4. English Radionics\$15.00
Dr. Ruth Drown's Reprints (Radio Therapy)
 5. Volume #1\$15.00
 6. Volume #2\$15.00
 7. Volume #3\$15.00
 8. Dr. Albert Abrams & Dr. Thomas Colson\$25.00
 9. Dr. J.W. Wigglesworth & The Pathoclast\$10.00
 10. Various Rates and Their Uses\$35.00
 11. Reprint: "The Secret of Life", By G. Lakhovsky ...\$15.00
Reports Available
 12. Tracking The Astronauts In Apollo "11"\$10.00
- When placing an order, please order by the number as well as the title of the book.

1980 - 1988

COSMICULTURE - THE NEW AGE AGRICULTURE

By: Dr. T. Galen Hieronymus

Let us begin our appraisal of the new System of Agriculture we call Cosmiculture with this very suitable quotation by Appolo Astronaut, Edgar C. Mitchell:

"There are no unnatural or supernatural phenomena; only very large gaps in our knowledge of what is natural. We should strive to fill those gaps of ignorance."

In our work for the last fifty-odd years, that is exactly what we have been doing! We have been pioneers in the exploration of subtle energies, in our attempt to fill the gaps in what is known about the higher, finer energies of matter and energy, outside the Electro-Magnetic Spectrum. We feel that so far we have been successful in our quest for knowledge, but we know there is still much to learn. In the nineteen-thirties, I did a successful experiment in an effort to learn if solar energy could be conducted over wires. When I found that it could, I realized what a tremendous sea of energy we on this planet are living in!

At that time we had not yet entered the Chemical Era in which we live today. Then there were no toxic chemical Pesticides and Herbicides, no sodium type commercial fertilizers. It is only since the Vietnam War that the nerve destroying toxic chemicals developed for chemical warfare have been recommended to the American Farmer for the purposes of killing insect pests and destroying weeds.

It is only lately that exorbitant prices for inadequate commercial fertilizers and all the modern medicines designed for livestock have made paupers of free-spirited farmers of this nation and other nations, wherever these Chemical-farming methods have been exported. Several years ago, as I saw the plight of the producers of the food of our nation, I got out my 1930 experiments and began seeking ways and means of using the sea of Free Energy all around us. The result of this experimentation is "The Cosmic Pipe" and our new method of farming we call "Cosmiculture".

First of all, the Rules of Eloptic or Subtle energy, apply to all phases of life on this planet, including the minerals and soil of the Planet. Everything is emanating energy, since all things are made of crystallized energy.

The Story of Eloptic Energy

It is generally accepted that the Atom is the building block of Nature. As Dr. Rudolph Steiner, the great pioneer of Bio-Agriculture wrote and taught, "the natural methods are the best methods. The natural energies provided by nature are the greatest remedies."

We have all around us, as Dr. Steiner reminded us in his lectures on Agriculture, a great sea of energy: cosmic energy, solar energy, lunar energy, planetary system energy from the planets of our solar system and the planetary energy or the Eloptic Energy of our planet Earth itself. Without sunlight or the solar energy, there would be no photosynthesis, and no full growth of plants; Ergo, no harvests. The other energies are more subtle, but necessary, nevertheless. We also have so much electromagnetic and sonic energy in the atmosphere today that the Federal Government has been considering limiting the number of radio and television stations licensed in the future, because of our present level of electronic and sonic smog.

All this is energy: free energy, which we found may be tapped and conducted over wires. We have been building and testing our Cosmic Pipe for the purpose of carrying these cosmic energies from space down into the soil to be used for the redemption of the farming land from the load of poisons the chemical means of agriculture has imposed upon it, and balancing the soil content.

In order to fulfill our quest for free energy for the farmer, and as a means of cleansing his land from poisons and growing healthy stock and crops, we have had to understand the situation of this planet orbiting in a sea of energies. We had to learn about methods of bringing the energies from the areas mentioned by Dr. Steiner, into practical contact with the earth and the roots of plants. We already had the results of our experiments for over fifty years, our Eloptic Energy Analyzer and Treatment Analyzers. The use of one of our Eloptic Energy Instruments will give the farmer a means of analyzing and treating poisons out of feed for stock, of eliminating insect pests by treating plants and at the same time raise the vitality of plants. Use of a "Genuine Hieronymus" Analyzer gives the farmer a wholistic method of analyzing and treating sick stock, improving the health of flocks, treating fields for improved yields, etc. with the energies of finer media. We trust at

the same time consciousness is being expanded so that we may all gain a little more understanding of these energies.

The "impossibility of the impossible" is no longer a true hypothesis as we discover more and more about the nature of energy and the various forms and distinctive categories of energies. All the results of our research of the past is becoming more and more credible today, in the light of what is becoming accepted by scientists and manifested in the everyday working world in which we live. So we combine the "Genuine Hieronymus" Eloptic Energy Analyzer and our proved methods of working with it for best results, with our new Cosmic Pipe, for the achievement of that type of Agriculture we call "Cosmiculture". We are now prepared with the "Genuine Hieronymus" Eloptic Energy Analyzer and Treatment Instrument and the Cosmic Pipe, to use the finer media energies for the benefit of mankind.

When the Cosmic Pipe has been installed, it is gathering "Cosmic" energies of space into its head, from the air, putting them down a conductor through a resonance chamber to a modulating well, where we place whatever we wish to modulate the energy with, and then it goes on down into the amplifier-radiator in the pipe, set at least two feet deep in the ground. There the modulated energies are broadcast horizontally in a broad band out through the soil to the roots of the plants. The results have been tremendous. For many years we have seen soil being treated with soil nutrients and the use of organic methods of culture show peaks and valleys of soil nutrient deficiencies. In the six years of testing Cosmiculture we have seen soil come into full balance in six months without the addition of tons of nutrients. Harvests have been doubled, the time of production shortened by two weeks to a month and the natural sugar content of fruits, melons and berries has been markedly increased. Hay crops have been tripled, with heavier bales.

Tests we have done in the evaluation of methods of gathering energy with the pipe have proved that large amounts of copper or aluminum used in some manufactured devices are extremely detrimental to people and cattle as well as plants, so I have eliminated aluminum in the pipe and held copper to the barest minimum possible. We have found that huge amounts of copper radiated into the ground

The Story of Eloptic Energy

through the soil have thrown the iron-copper balance out of harmony, decreasing the amount of iron in the soil and increasing the amount of copper beyond the needs of plants.

The Pipe also has had some effect on the weather in the areas where we have these installed, in fifteen different states. In our own vicinity, we have noticed that we no longer have violent weather and storms. The rain is gentle and falls often. Temperatures have been mild, compared with temperature before we installed the big pipe in our land.

We teach the farmer Cosmiculture with the Cosmic Pipes, to bring energy into the various fields and to modulate the soil with the Reagents needed by the soil, and with the "Genuine Hieronymus Eloptic Energy Analyzer and Treatment Instrument. We now can define this as a Wholistic method of agriculture which includes use of Natural Cosmic energies for the soil balance and rejuvenation, the use of the Analyzer and Treatment Unit to balance animal and poultry digestive systems, analyze the animals needs, analyze soils and organics, analyze and treat out water pollutions and take care of insect pests. We show you how to graph your data so that you can read and understand the balances and imbalances in you soil, crops, seed and plants.

In this manner, with the tools of Cosmiculture, you can have a definite work-plan, based on definite (not guessed at) evaluation of each field's individual needs, the health and food needs of your animals and chickens and turkeys and a means of correcting such health problems that have resulted from long time feeding of poisoned feedstuffs. We teach you to eliminate the costly guessing techniques now in practice among the "orthodox" farming methods, allowing you to avoid expensive duplication in plant and animal food and health programs. Thus you are able to individually monitor with the "Genuine Hieronymus" Eloptic Energy Analyzer and Treatment Instrument, the problem areas and know for sure just where help is needed and give the help needed immediately. You can take care of pollution problems and eliminate expensive pesticides and fertilizers. At the same time, your Cosmic Pipe equipment is balancing and harmonizing you soil, with free energies of Cosmic strength and power, resulting in soil balance, rejuvenation of soil, enrichment of soil, revitalization of soil and harmonizing of soil. This treatment of the soil results in earlier

1980 - 1988

fruition, increased yield, higher quality, nutritious crops, healthier stock, greater profits, elimination of pesticides and reduction in the use of fertilizers. The quality of the food you produce will be greatly improved. The net result, of course, is more money in you own pocket; a reward for your labor and the satisfaction that is every farmer's birthright: Satisfaction with your work and it's rewards and Joy in living a harmonious life.

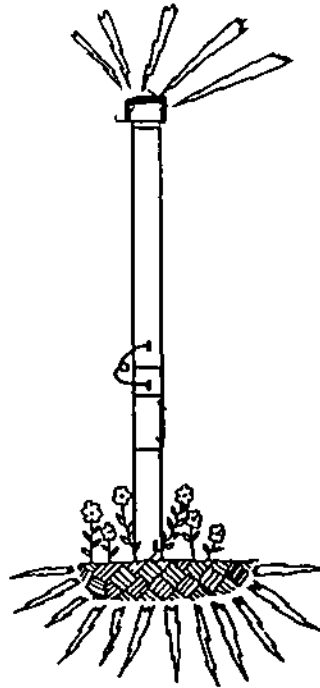

The Story of Eloptic Energy

CONDUCTING CHLOROPHYLL ENERGY OVER WIRES

About 1930, I decided to try an experiment of conducting Chlorophyll Energy over wires. I had been conducting Eloptic Energy over long distance via wire.

A wood platform was installed on the south side of the house about six feet above the ground in order to get the desired potential of energy which increases with distance above the ground.

Having some wooden cigar boxes available, I cut boxes apart and cut pieces and made eight boxes that were 2" x 2" x 4" although any size boxes will work.

Aluminum foil was placed on the bottom of seven boxes inside so as to be in contact with the soil. Similar pieces of foil were placed on the under side of the lid of each box. Wires were connected to each piece of foil, the wires from the lids were extended to the sun plates, the wires from the bottom foils were connected to the water pipe and thus grounded. See Figure #2 for details of the box construction.

Refer to Figure #1 which shows a "side" view of the installation. Figure #3 shows the system of connections.

Seven plates were placed on the platform so as to pick up energy from the sun and a wire was connected to each plate and extended down into the basement, each box having the top foil plate connected via wire to a plate out on the platform in the sunlight. The eighth box had no connection to the outside, it being the "control".

The plates on the platform were all different in size. The smallest was 2" x 4", the next 4" x 8", the largest was about 8" x 10" and one plate was copper screen wire.

Some dirt was screened and 1/2 inch of dirt placed in each box. Oat seeds were selected, all of uniform size and planted in two rows of 5 seeds spaced in each row, the 1/2" of dirt was placed on top in the box. The same amount of water was added to each box as needed from day to day.

All of the seeds sprouted about the same time. Then we noticed that there was no chlorophyll in the 10 plants in the control box. All of the boxes connected to outside plates had plants with much chlorophyll.

We were quite surprised to note that the plants in boxes with large outside plates seemed to look as if they

had been subjected to heat. Apparently the large outside plates were bringing in an excess of energy compared with the effect of the small size outside plates.

Very soon, the plants grew too tall for the small amount of "head room" in the boxes so each box was equipped with a spacer to raise the top of each lid up about 3/4".

The boxes were placed on a shelf in the end of the basement where there was little light, with no windows at that end. Also, the shelf was kept dark by a board placed in front and another on top to exclude all light. The plants were dark all of the time except when they were examined by a flashlight.

A friend tried to duplicate the experiment, but did not follow all instructions. Their basement was only about 3 feet from basement floor to ground level outside. Instead of placing the outside plates above ground 6 feet, they laid on the ground, thus they did not have the potential difference between outside collector and inside boxes and the experiment was a failure. Also, there was a window near that let much light into where the boxes were placed.

Anyone who expects to duplicate an experiment should be sure they know all the factors and that they follow the instructions exactly without any substitution or change. And as to changes, if you are trying to get a special result and are trying out several methods or ideas, one of the cardinal points to doing good work is to make just one change at a time. Then you know just what the results are. If you make two changes and the result is a failure, you do not know but that one of the changes and the result is a failure, you do not know but that one of the changes may have been alright. (See Figures #1, 2, and 3 next page).

By: Dr. T. Galen Hieronymus

The Story of Eloptic Energy

THE PORTABLE ELOPTIC ANALYZER/TREATMENT UNIT

This instrument is used to analyze, monitor, and positively manipulate Eloptic Energy.

It is used for animal and family needs, treating crop plants, raising the energy of fields and crops, soil testing, plant growth analyzing, treating animal and plant health, etc. This portable energy package includes: The Portable Eloptic Analyzer/Treatment Unit (which comes in its own case with lid for easy transport), Two books (The Eloptic Energy Manual and The Cosmiculture Manual), assorted Reagents, and a wall socket power supply. As with all of our instruments, it comes with a one year warranty against defects in manufacturing and workmanship.

THE SMALL PORTABLE ELOPTIC ANALYZER UNIT

This is a new instrument that we have recently developed in response to several requests for an individual analyzing unit.

It utilizes the analyzing components from our Portable Analyzer/Treatment Unit, but it does not contain any of the treating components. It is only used for analyzing. This instrument is very good for those of you who want to continuously monitor and analyze an ongoing project. It is also excellent when used with some of our other instruments and equipment such as our Beam Projectors or our Cosmic Pipes for various and assorted projects.

This package includes: The Small Portable Eloptic Analyzer Unit, a Small Rate Book, several test charts, and a wall socket power supply. This instrument also includes a one year warranty.

THE SPECIFIC RATE BEAM PROJECTOR

This instrument utilizes the treating capability of the Portable Analyzer/Treatment and has the versatility of the Reagent Beam Projector. It can be used in much the same way as the Reagent Beam Projector, but it has the bonus of being able to treat on specific rates of Eloptic Energy to cancel out negative conditions, much the same way the Portable Analyzer/Treatment Unit works in treatment mode. It is great for using in conjunction with the Portable Analyzer/Treatment Unit if you have a project where you do not want to tie up your analyzing instrument while you are treating out a problem.

This package includes: The Specific Rate Beam Projector, Selected Farm Reagents, One Book (The Cosmiculture Manual), a wall socket power supply, and a one year warranty.

THE HOMEOPATHIC PREPARATOR

This instrument is another one of our new designs recently developed. It was developed in response to requests from those people who are working with large amounts of Homeopathic Preparations.

This instrument utilizes some of the technology that went into the development of the Reagent Beam Projector, but with the central design purpose being that of preparing Homeopathic Preparations. This instrument is very useful to those researchers who prepare large amounts of Homeopathic Preparations at one time.

This package includes: The Homeopathic Preparator, One Book, Two Kits of Homeopathic Remedies suitable for EXPERIMENTAL USE in treating, a wall socket power supply, and a one year warranty.

THE COSMIC PIPE

The Cosmic Pipe is a self-driven broadcaster used directly in the field to stimulate biological transmutation and effect a balanced harmony in the soil, resulting in improved quality and quantity. When the Cosmic Pipe has been installed, it is gathering the "Cosmic" energies of space into its head, from at least six feet in the air, putting them down a conductor through a resonance chamber to a modulating well, where we place whatever we wish to modulate the energy with and then it goes deep into the ground. There, the modulated energies are broadcast horizontally in a broad band out through the soil to the roots of the plants. The results have been tremendous.

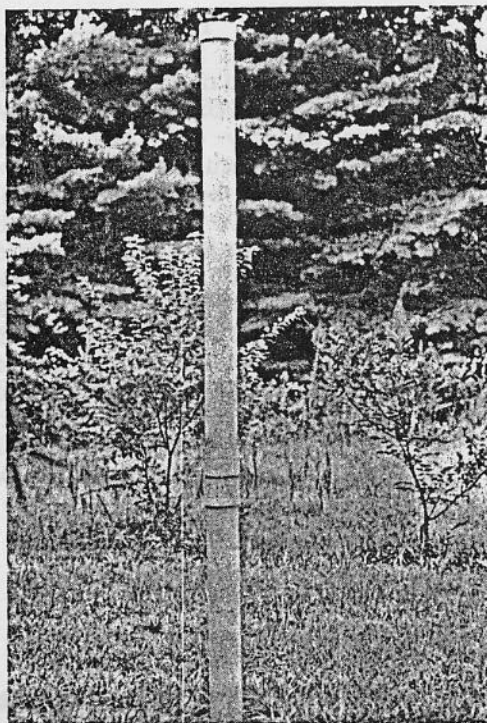

For many years, we have seen soil being treated with soil nutrients and the use of organic methods of culture show peaks and valleys of soil nutrient deficiencies. In the years of testing Cosmiculture, we have seen soil come into full balance in six months without the addition of tons of nutrients. Harvests have doubled, the time of production has been shortened by two weeks to a month and the natural sugar content of fruits, melons, and berries has been markedly increased.

The Cosmic Pipe is offered in three sizes: Small (up to 10 acres*), Medium (up to 640 acres*), and Large (up to 2500 acres*).

*Acreage may vary due to terrain. All of the Pipes come with instructions and Selected Farm Reagents.

1980 - 1988

ILLINOIS DAIRY TEST SUPPLEMENT

Gene Litweller, Dealer
Phone (815) 389-2720

<u>Date</u>	<u>Pounds of Milk/Day</u>	<u>Income Increase</u>
April 26, 1985	Cosmic Pipeline Installed	
May 10, 1985	Approximate time of "Shed-down"	
" 15 "	-0-	-0-
" 16 "	12.0	1.56
" 17 "	114.0	14.82
" 18 "	150.0	19.50
" 19 "	150.0	19.50
" 20 "	125.9	16.37
" 21 "	223.5	29.05
" 22 "	272.3	35.40
" 23 "	400.4	52.05
" 24 "	467.5	60.78
" 25 "	461.4	59.98
" 26 "	559.0	72.67
" 27 "	491.9	63.95
" 28 "	461.4	59.98
" 29 "	444.0	57.72
" 30 "	480.0	62.40
" 31 "	522.4	67.91
		<u>67.91</u>
		\$ 693.64 TOTAL

*Note: Milk prices based on Average \$13.00 per cwt.

The Story of Eloptic Energy

ILLINOIS DAIRY TEST

March 24, 1985	Soil Test from Map	Average 292.28
April 26, 1985	Installed "Cosmic Pipeline"	
May 14, 1985	Soil Test from Map	Average 637.0
May 31, 1985	Soil Test from Map	Average 687.14

<u>Date</u>	<u>Milk Record</u>	<u>Daily Production</u>	<u>Notes</u>
May 15, 1985	34.4/cow	2064.0 #	Cows on "old" feed this date.
" 16 "	34.6	2076.0 *60 cows	Cows started feeding Greenchops "new" feed.
" 17 "	36.3	2178.0	
" 18 "	36.3	2214.3	Added one cow
" 19 "	36.3	2214.3	
" 20 "	35.9	2189.9	
" 21 "	37.5	2287.5	Started feeding "new" Alfalfa Hay.
" 22 "	38.3	2336.3	
" 23 "	40.4	2464.4	*61 cows
" 24 "	41.5	2531.5	
" 25 "	41.4	2525.4	
" 26 "	43.0	2623.0	
" 27 "	41.9	2555.9	
" 28 "	41.4	2525.4	
" 29 "	41.8	2508.0	
" 30 "	42.4	2544.0	*60 cows
" 31 "	42.4	2586.4 - *61 cows	
		40,508.5 #	

* 27 of 61 cows are first-calf heifers.

	<u>Bacteria Count</u>	<u>Wisconsin Mastitis Test</u>
Dec.	68,000	12
Jan.	11,000	9
Feb.	22,000	15
Mar.	17,000	24
Apr.	15,000	20
May	2,000	10
June	79,000	-
July	1,000	-

1980 - 1988

**ADVANCED SCIENCES
RESEARCH and DEVELOPMENT CORPORATION, Inc.**

Dr. T. Galen Hieronymus, Ph.D.
President

Dr. Sarah E. Hieronymus, Ph.D.
Secretary-Treasurer

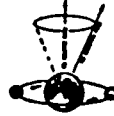

P. O. Box 109
Lakemont, Georgia 31
(404) 782-6347

RON SCHULTZ, Dealer
Buxton, North Dakota

	Commercial Wheat \$50.00 per acre	Cosmiculture Wheat Pipe installed Jan. '85	Percent Increase
Seed Weight	Av. .36905 g/seed	Av. .4222 g/seed	+14.40%
Seed Head Count	42 @ 15.5g	45 @ 19.0g	7.14%
Seed Width	Av. 336.6mm	Av. 341.7mm	+ 1.52%
Range sm/g	306/355 (49mm)	334/350mm (16mm)	
Stalk diameter.	205.5mm	Av. 247.5mm	+20.44%
Stalk Wall Thick- ness	27.5mm	37.5mm	+36.36%

COSMICULTURE ENERGY FEED ANALYSIS

	Energy	Digestability	Feed Assim.	Protein Content	Mineral Imbal.	Chemical Poison	Metall Poison
Cosmi Wheat	786	595	738	485	73	52	64
#50 Fert. Wheat	436	210	394	205	67	54	77

	Protein	Bushel Weight	Yield	Sold**	Gross/Ac	Cost	Net//
Cosmic Wheat	11%*	58#	50 bu/ac	\$2.14	\$107.00	\$ 2.00	\$105.00
Commercial Wheat	12.3%	59#	50 bu/ac	\$2.68	\$134.00	\$50.00	\$ 84.00

Note: * Wet weather caused four-weeks delay in harvest.
** Price based on 13% protein scale.

When Iowa Lays on the Paper

The use of law is ever a fascinating subject. Attorney Generals opine, prosecutors make deals, wash out charges and in general act tough when they have helpless people under chain and gun. Some months ago, the Attorney General of Iowa laid some paper on just about everyone in sight connected with radionics. For reasons not at once apparent, the Attorney General's Office of Iowa decided—without understanding the grammar of the subject—that those who dealt with eloptic energy were defrauding the public. As proof, these guardians of citizens' wallets likely plan to call up people who have never spent ten minutes investigating the subject, and therefore aren't worth talking to.

There are about 300 farm magazines in the U.S. *Acres U.S.A.* is perhaps alone in reporting on things like Tesla's multiple wave oscillator, cosmic pipelines, towers of power—on radionics, in short, and other forms of fringe science that have been around for decades—even a century—and if Dr. Phil Callahan is correct, *centuries!* We have wondered aloud why those who wish to experiment with these things in order to unveil nature's secrets have to flee to dictatorships in order to find a little freedom.

Radionics is simply a low level energy system that can be directed. Dr. Pat Flanagan explained the concept in an *Acres U.S.A.* interview. "When an operator's mind and emanations from the tuner are on the same wavelength, a type of resonance is established, and the detector indicates this mode. The Hieronymus detector is simply a sheet of bakelite or plexiglass under which is placed a flat spirally wound coil, connected to the output of the amplifier and the ground. When resonance is established, there is a change of tactile characteristic in the top of the detector. The change of characteristic is detected by lightly running the fingertips on the surface of the detector plate while tuning the vernier dial of the prism. Hieronymus established numbers which correlate with the known chemical elements and combinations. . . . Although the Hieronymus machine cannot be explained by modern physics, it does have merit by the fact that results can be duplicated."

Mark the words, *can be duplicated*. It is well known that there are thousands of radionic units in the field. Farmers using the scanner for instant soil tests have caused traffic to the testing labs to fall out of bed. Is this the reason for the Iowa Attorney General's sudden interest in how people spend their money?

There is something ludicrous about government people worrying about the welfare of a citizen's wallet in any case. Governments are proficient in only four areas—killing, stealing, lying and making woodenheaded decisions, including one to destroy individual businesses. Determining the secrets of nature is simply beyond the scope of an Attorney General's office. Thus enters the so-called expert—in this case someone who has concluded in advance that density on a photograph says nothing, that cells do not vibrate, that energy forms other than electromagnetic do not exist, on and on.

Our bodies contain approximately 200 quintillion cells. In this fabulous number there are hardly two cells vibrating with the same frequency. This being partly due to the incessant activity taking place within the cells, and partly to the specific characteristic of different tissues, plus other factors. From a biological point of view, it would be impossible to find at any given time two individual cells exactly alike in every respect. Every cell of every individual tissue of any particular species—land, animal or man—is characterized by its own oscillatory shock. In disequibrated cells, it would be necessary to generate as many wavelengths as there are different cells in any given body. The problem would thus seem to be insoluble. With remarkable insight Georges Lakhowsky finally evolved a solution. He designed a new type of apparatus, the multiple wave oscillator, generating a field in which every cell could find its own frequency and vibrate in resonance. The practical results he obtained in various hospitals soon confirmed the validity of his theory. His agricultural experiments were equally impressive.

Lakhowsky came to New York. He was promptly run down by a car. Against his wishes the drivers took him to a hospital. In three days he was gone. Had he survived, he might have gone to Iowa, where an Attorney General—who did not have the foggiest notion of what it was all about—would have laid some paper on him.

There is no end to government agencies making fools of themselves. What did the government really accomplish by jailing Wilhelm Reich and Victor Irons? What did the American gestapo really achieve by smashing the electronic end of cell therapy and making the nation safe for coal tar derivative drugs?

In any fair arena, a literate person could mop up the floor with the Iowa Attorney General's office, but such an arena is not available. So the battle is tilted the other way. Served with papers suitably leaked to the press, Harley Ahrens of Morrison, Illinois was promptly fired from his school job. Minnesota veterinarian Dan Skow was forced to sue for peace, figuratively smashing his machine. Across the nation farmers cower. No one can afford to fight the Iowa Attorney General fraud boys. A piece of paper served on anyone instantly costs and costs and costs. Win, lose or draw, the victim is punished and the government people laugh all the way to the bank, and perhaps when enjoying all that sick leave for not being sick. No one has a problem defending \$125.00 an hour for worthless legal conversation, but new ideas can't be tolerated.

The farmer is entitled to more. He is entitled to be left alone so these fringe sciences can sort themselves out, with the valid surviving. But there is danger in this. The answers might come out wrong for the fossil fuel industry, the grant slurping professors, and the bureau people who have a vested interest in upholding the four pillars of government mentioned above.

acres, USA.
A VOICE FOR ECO-AGRICULTURE

MAY 1987
VOL 17, NO 5

THE
NEW YORK
ACADEMY OF SCIENCES

PRESENTED TO

U. Galen Hieronymus

IN RECOGNITION AND CERTIFICATION OF BEING ELECTED
AN ACTIVE MEMBER OF

THIS ACADEMY

October 28, 1982



Mc-
PRESIDENT

Allen
SECRETARY

INTERNATIONAL BIOGRAPHICAL ASSOCIATION

Registered in the United Kingdom

Director-General: Ernest Kay, D.Litt., F.I.B.A.

I have the honour to inform you that you were this day elected a Fellow of the International Biographical Association by unanimous decision of the Board sitting at Cambridge, England. Further, it was decided by the Board to issue to you the official I.B.A. Passport and to accord to you all privileges of Fellowship.

I beg to remain,
Your obedient servant,

Director - General.

16th April 1984

Dr. T. G. Hieronymus

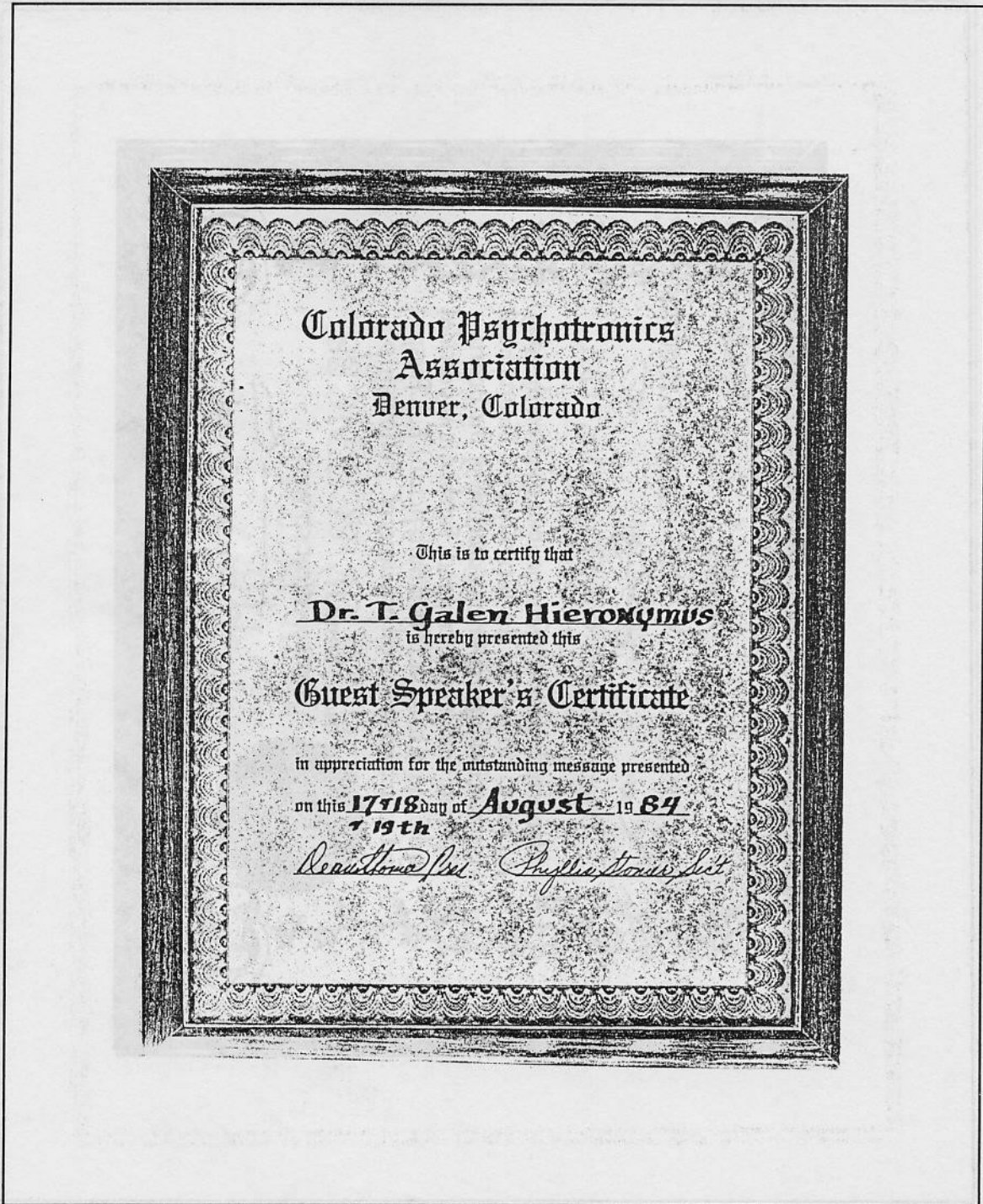

WORLD UNIVERSITY ROUNDTABLE
In Corporate Affiliation with the World University

Greetings

In recognition of Distinguished Achievement within the principles and purposes of the World University development, the Trustees of the Corporation, upon the nomination of the Secretariat, confer doctoral membership and this honorary award upon

T. Galen Hieronymus
The Cultural Doctorate in
Psychotronic Science

with all rights and privileges there to pertaining.

Given at Tucson, Arizona on the
Month and Day Here Recorded ~
May 9, 1985

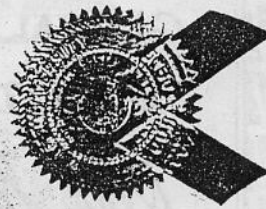

Thomas A. Bick
President of the Board
Lawrence S. Rader
Secretary of the Board of Trustees

**Global Sciences Institute
Denver, Colorado**

This is to certify that

DR. T. GALEN HIERONYMUS

is hereby selected

Youth of the Month

for outstanding service and contributions to

GLOBAL SCIENCES CONGRESS

on this 15th day of AUGUST 19 86

Dean Stone

Phyllis Stovier

1980 - 1988



The Journal of Borderland Research

VOLUME XLIV, No. 3

May-June 1988

- * REFLECTIONS ON THE PLAGUE YEARS
Michael Urban, Ph.D. {1-5}
- * BACK TO BACH
Michael Theroux {6-9}
- * THE TRANSMISSION OF ELECTRICITY, Part II
Eric Dollard {10-12}
- * PLUS SLITS - MINUS SLITS
Jay Christopher {13}
- * T. GALEN HIERONYMUS 1895-1988
Radionic Pioneer {14}
- * GROWING PLANTS IN THE DARK
T. Galen Hieronymus {14}
- * HOW CRESS SEEDLINGS RESPOND TO LIGHT AND "FEEDING"
Simon Martin {15-17}
- * IS PSYCHOTRONIC PEST CONTROL POSSIBLE?
William S. Peavy, Ph.D. {18-19}
- * THE FUNCTION OF THE PROTECTIVE SKIN
Rhetta and Walter Baumgartner {20-21}
- * RECENT SIGHTINGS OF UFOS AND A LAKE MONSTER IN ARGENTINA
Jorge Resines {22-25}
- * THE STORY OF THE 13th ASTROLOGICAL SIGN
Dr. W.G. Reimer and Art Yensen {26-28}

- * VIEW FROM THE BORDERLANDS by Tom Brown
- The Search For Radionic Truths - Radionics and
Psychotronics - Cosmic Weather Reports - Sunspots and the
Weather - Clouds and the Weather - Cosmic Activity and
Plant Growth - Astrological Charts - Solar Cycle 22 So Far -
- The Changing Earth - Contacts - - BSRF Business -
- 1987 Financial Statement - BSRF Literature... {29-36}

The Story of Eloptic Energy

T. GALEN HIERONYMUS - Radionic Pioneer
November 21, 1895 to February 21, 1988

We mark the passing of Dr. T. Galen Hieronymus who was a true pioneer in the field of radionics. Dr. Hieronymus was a discoverer of unique attributes of the life force which he termed "eloptic energy". His work has stimulated continuing research in radionics. His patent No. 2,482,773 has become a standard concept which many radionic instruments have been built from, some using just the pattern drawn on paper. People with original thoughts are few and far between. Galen's presence on this earth has influenced many to look beyond the norm and Borderland Sciences Research Foundation honors a man who blazed a trail for others to follow. Rather than eulogizing, we present an important experiment from his patent for future researchers to work with.

Growing Plants in the Dark by T. Galen Hieronymus

Radiations from each of the known elements of matter produce some form of energy, probably electrons which can be made to flow along electrical conductors. The flow from each of the elements having characteristics different from the others. Conversely, the flow of electrons along a conductor produces a radiation having characteristics of the radiation from each respective element.

Such of the known elements as are required to feed growing plants have been transmitted to the plants through metallic conductors as the plants were entirely isolated from the elements upon which they were fed. More precisely, seeds were planted in boxes in a darkened basement room.

One of the boxes of plants containing some of the seeds was used as a control and no apparatus for transmitting element radiations thereto provided. The remaining boxes of plants had electrodes or plates of conducting material mounted or otherwise disposed adjacent thereto, and each box of plants was separately attached to a conductor extending to a point outside the building where electrodes or plates were attached to the conductors and allowed to remain exposed to the light.

Such of the known elements as required to impart normal characteristics to the plants were apparently fed thereto by having the radiations of the elements from the light conducted to the plants through the wires and associated electrodes.

The treated plants were relatively healthy but the control plant assumed the characteristics of growing vegetation which has been deprived of the elements in natural light. Particularly was the control plant devoid of chlorophyll while the remaining plants were green.

Dr. Hieronymus' work will be carried on by his wife Sarah and their co-workers at Advanced Sciences Research and Development Corporation, PO Box 109, Lakemont, Georgia 30552.